

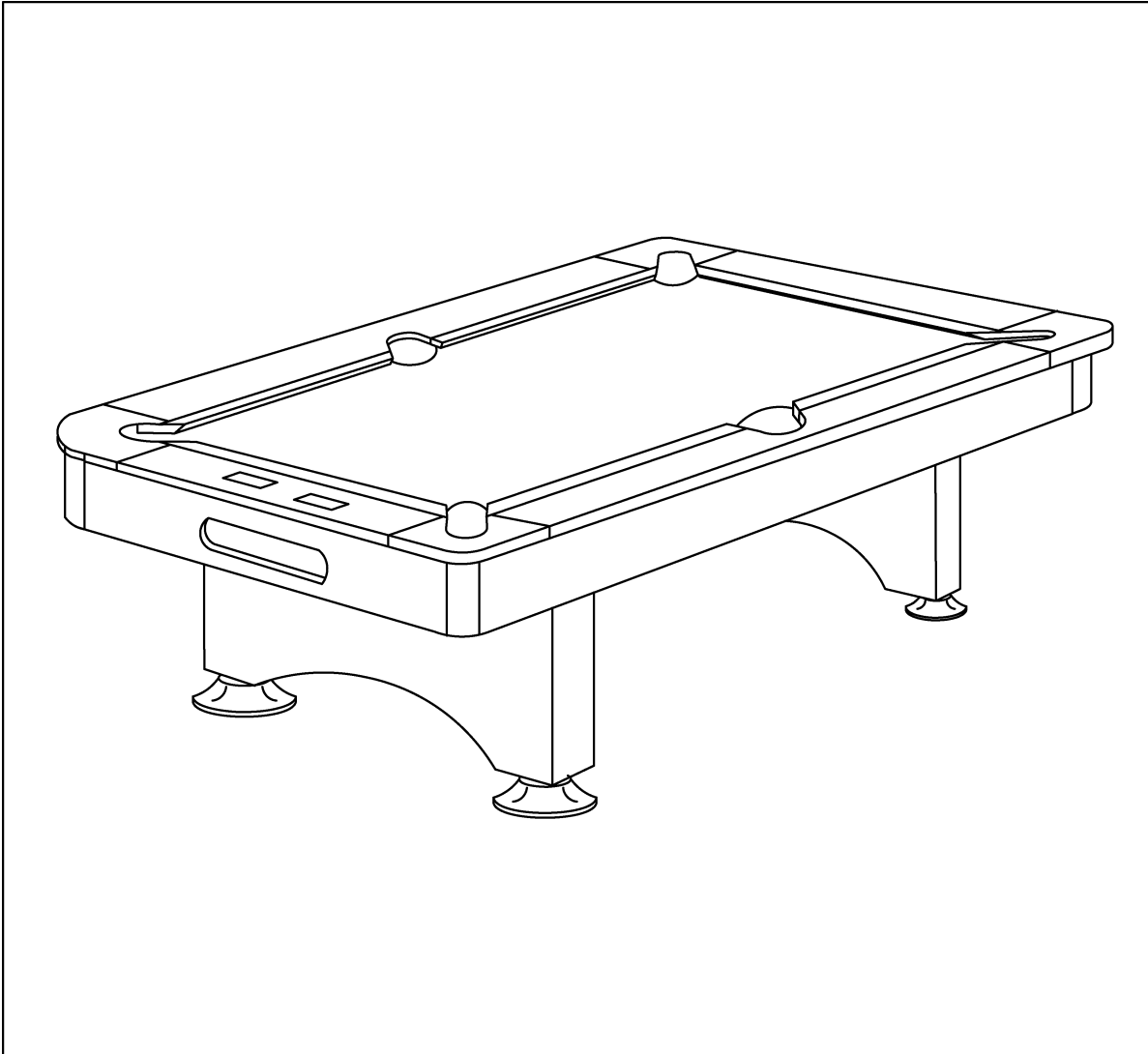

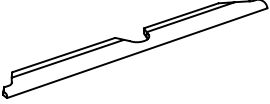

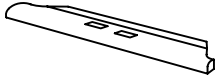





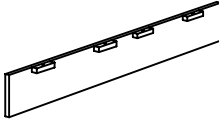
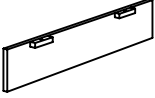
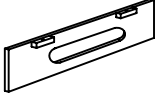
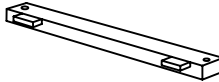

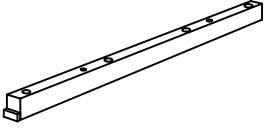
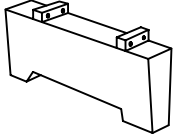
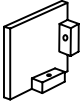

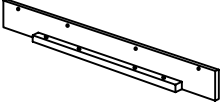



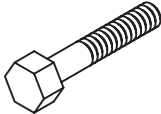

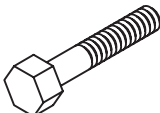
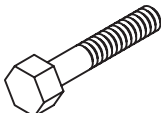
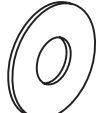
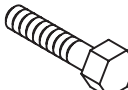

# BILLARDTISCH „OLYMPIC“

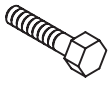

Art.-Nr.: 6091.1  
3153.1  
6093.1  
7147.1

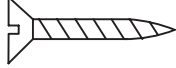
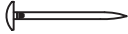
## Bauteile

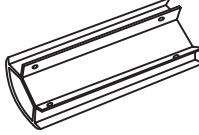
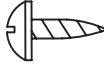
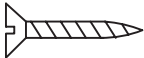
<p><b>A</b></p>  <p>Bandenrahmen lange Seite 2 Stück</p>	<p><b>B</b></p>  <p>Bandenrahmen kurze Seite (A) 1 Stück</p>	<p><b>C</b></p>  <p>Bandenrahmen kurze Seite (B) 1 Stück</p>	<p><b>D</b></p>  <p>Lange Seitenverblendung 2 Stück</p>
<p><b>E</b></p>  <p>Kurze Seitenverblendung (A) 1 Stück</p>	<p><b>F</b></p>  <p>Kurze Seitenverblendung (B) 1 Stück</p>	<p><b>G</b></p>  <p>Querstrebe 2 Stück</p>	<p><b>H</b></p>  <p>Mittlere Querstrebe 2 Stück</p>
<p><b>I</b></p>  <p>Langes Rahmenteil 2 Stück</p>	<p><b>J</b></p>  <p>Bein 2 Stück</p>	<p><b>K</b></p>  <p>Ballrücklauf (A) 2 Stück</p>	<p><b>L</b></p>  <p>Ballrücklauf (B) 1 Stück</p>
<p><b>M</b></p>  <p>Ballrücklauf (C) 1 Stück</p>			

<p>#1</p>  <p>Höhenverstellbarer Fuß 4 Stück</p>	<p>#2</p>  <p>Schraube 8 Stück</p>	<p>#3</p>  <p>Unterlegscheibe 32 Stück</p>	<p>#4</p>  <p>Mutter 16 Stück</p>
<p>#5</p>  <p>Schraube 8 Stück</p>	<p>#6</p>  <p>Schraube 4 Stück</p>	<p>#7</p>  <p>Unterlegscheibe 4 Stück</p>	<p>#8</p>  <p>Schraube 30 Stück</p>
<p>#9</p>  <p>Unterlegscheibe 12 Stück</p>	<p>#10</p>  <p>Unterlegscheibe 18 Stück</p>	<p>#11</p>  <p>Schraube 8 Stück</p>	<p>#12</p>  <p>Unterlegscheibe 8 Stück</p>
<p>#13</p>  <p>Eckverblendung 4 Stück</p>	<p>#14</p>  <p>Schraube 8 Stück</p>	<p>#15</p>  <p>Unterlegscheibe 8 Stück</p>	<p>#16</p>  <p>Schraube 12 Stück</p>
<p>#17</p>  <p>Nagel 18 Stück</p>	<p>#18</p>  <p>Ballfangtasche 6 Stück</p>	<p>#19</p>  <p>Verblendung Ecke 4 Stück</p>	<p>#20</p>  <p>Schraube 16 Stück</p>
<p>#21</p>  <p>Schraube 4 Stück</p>	<p>#22</p>  <p>Sechskantschlüssel 1 Stück</p>		

## Schritt 1:

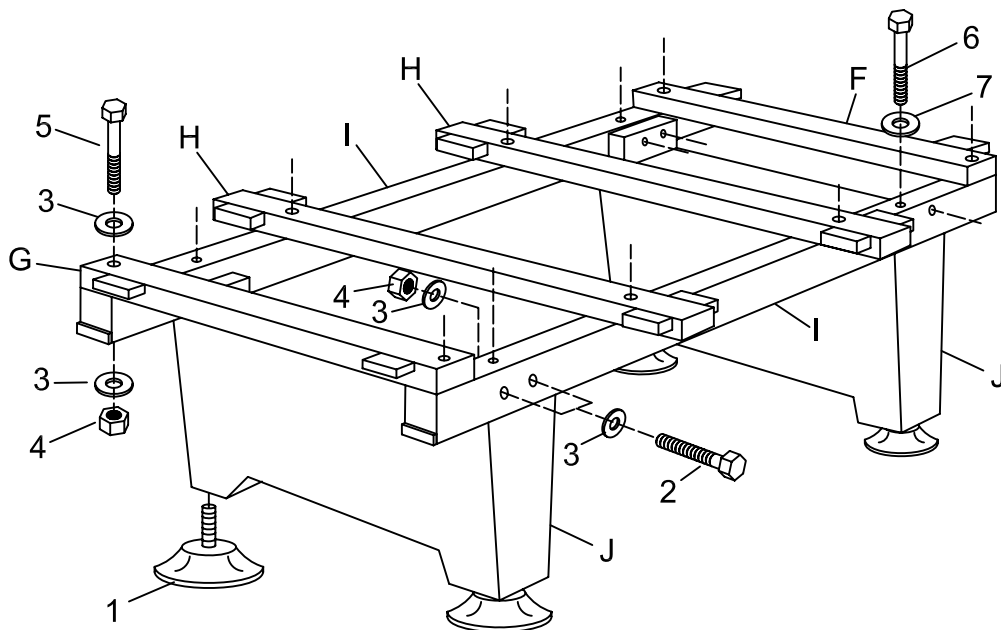

## Schritt 2:

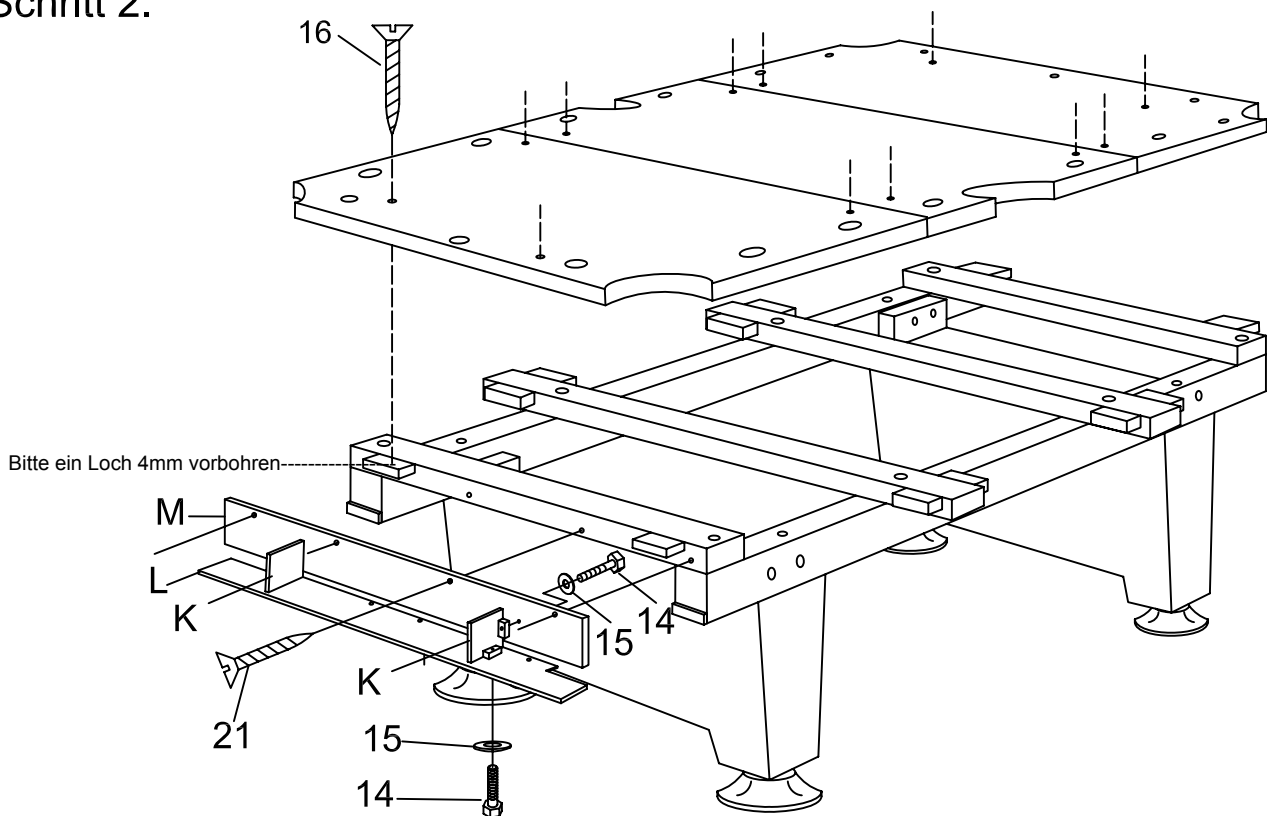

Schritt 3:

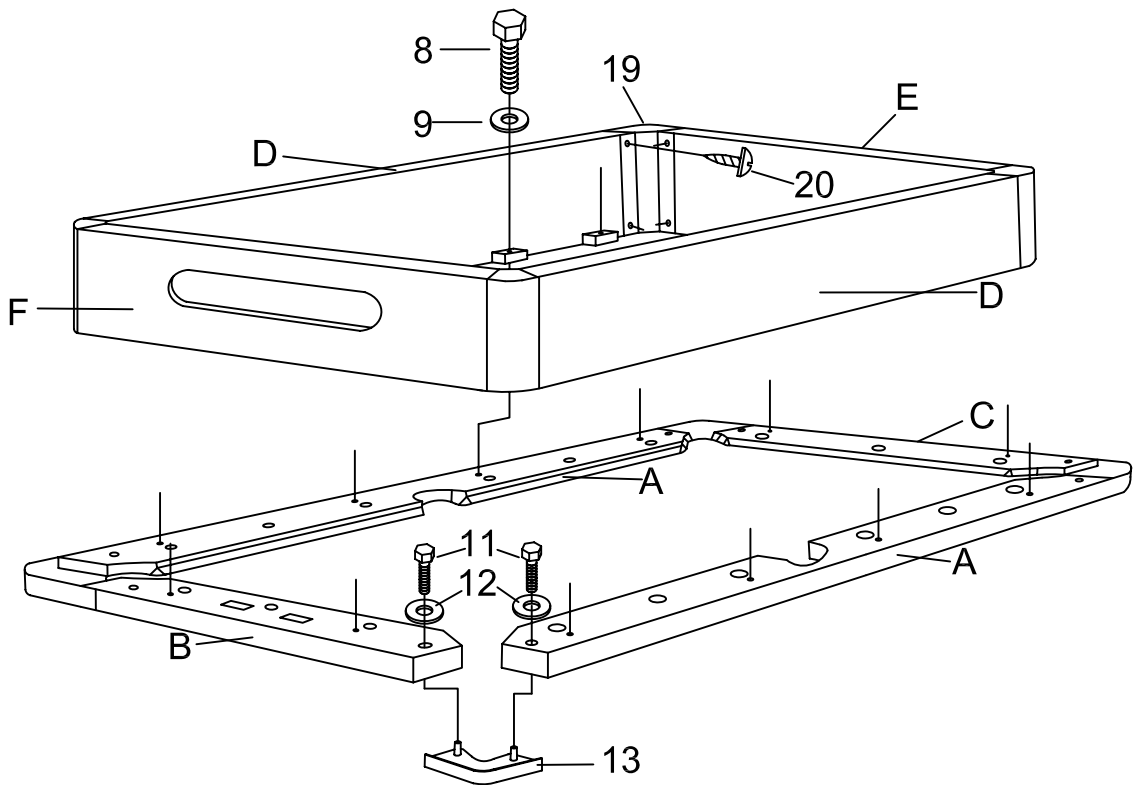

Schritt 4:

