

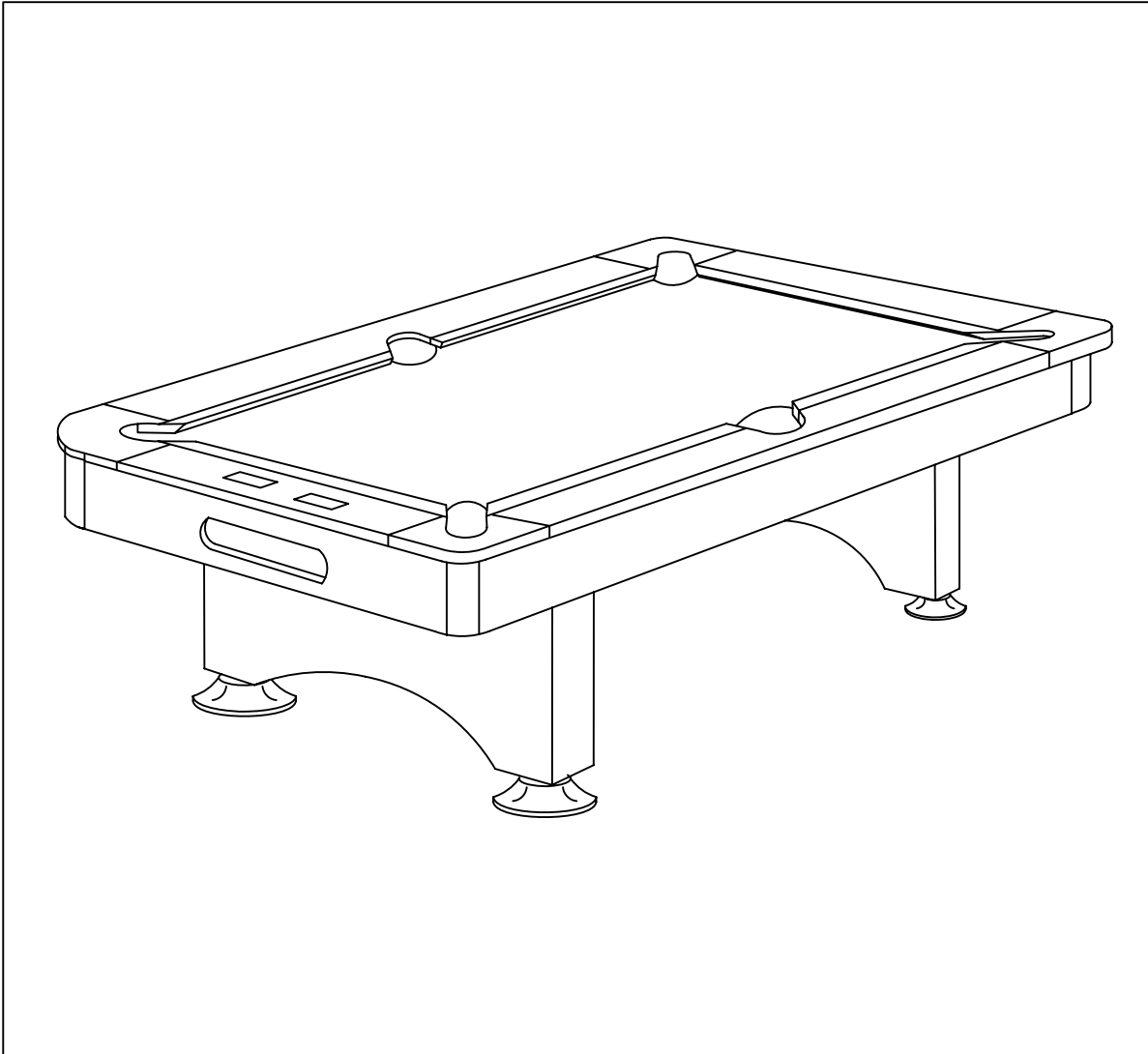

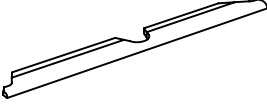

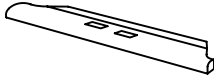





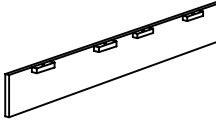
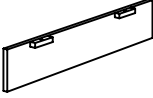
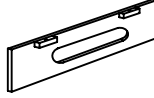
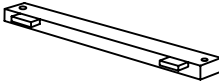

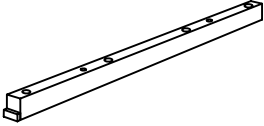
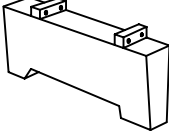
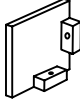

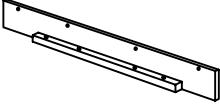



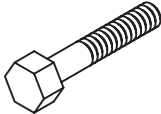

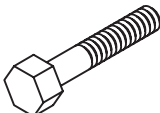
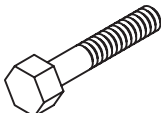
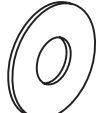
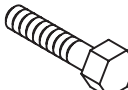

# BILLARDTISCH „OLYMPIC“

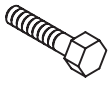

Art.-Nr.: AUT-7147  
AUT-3153  
AUT-6097  
AUT-6093

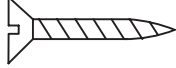
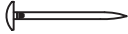
## Bauteile

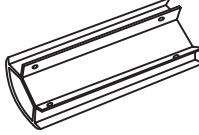
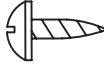
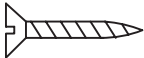
<p><b>A</b></p>  <p>Bandenrahmen lange Seite 2 Stück</p>	<p><b>B</b></p>  <p>Bandenrahmen kurze Seite (A) 1 Stück</p>	<p><b>C</b></p>  <p>Bandenrahmen kurze Seite (B) 1 Stück</p>	<p><b>D</b></p>  <p>Lange Seitenverblendung 2 Stück</p>
<p><b>E</b></p>  <p>Kurze Seitenverblendung (A) 1 Stück</p>	<p><b>F</b></p>  <p>Kurze Seitenverblendung (B) 1 Stück</p>	<p><b>G</b></p>  <p>Querstrebe 2 Stück</p>	<p><b>H</b></p>  <p>Mittlere Querstrebe 2 Stück</p>
<p><b>I</b></p>  <p>Langes Rahmenteil 2 Stück</p>	<p><b>J</b></p>  <p>Bein 2 Stück</p>	<p><b>K</b></p>  <p>Ballrücklauf (A) 2 Stück</p>	<p><b>L</b></p>  <p>Ballrücklauf (B) 1 Stück</p>
<p><b>M</b></p>  <p>Ballrücklauf (C) 1 Stück</p>			

<p>#1</p>  <p>Höhenverstellbarer Fuß 4 Stück</p>	<p>#2</p>  <p>Schraube 8 Stück</p>	<p>#3</p>  <p>Unterlegscheibe 32 Stück</p>	<p>#4</p>  <p>Mutter 16 Stück</p>
<p>#5</p>  <p>Schraube 8 Stück</p>	<p>#6</p>  <p>Schraube 4 Stück</p>	<p>#7</p>  <p>Unterlegscheibe 4 Stück</p>	<p>#8</p>  <p>Schraube 30 Stück</p>
<p>#9</p>  <p>Unterlegscheibe 12 Stück</p>	<p>#10</p>  <p>Unterlegscheibe 18 Stück</p>	<p>#11</p>  <p>Schraube 8 Stück</p>	<p>#12</p>  <p>Unterlegscheibe 8 Stück</p>
<p>#13</p>  <p>Eckverblendung 4 Stück</p>	<p>#14</p>  <p>Schraube 8 Stück</p>	<p>#15</p>  <p>Unterlegscheibe 8 Stück</p>	<p>#16</p>  <p>Schraube 12 Stück</p>
<p>#17</p>  <p>Nagel 18 Stück</p>	<p>#18</p>  <p>Ballfangtasche 6 Stück</p>	<p>#19</p>  <p>Verblendung Ecke 4 Stück</p>	<p>#20</p>  <p>Schraube 16 Stück</p>
<p>#21</p>  <p>Schraube 4 Stück</p>	<p>#22</p>  <p>Sechskantschlüssel 1 Stück</p>		

## Schritt 1:

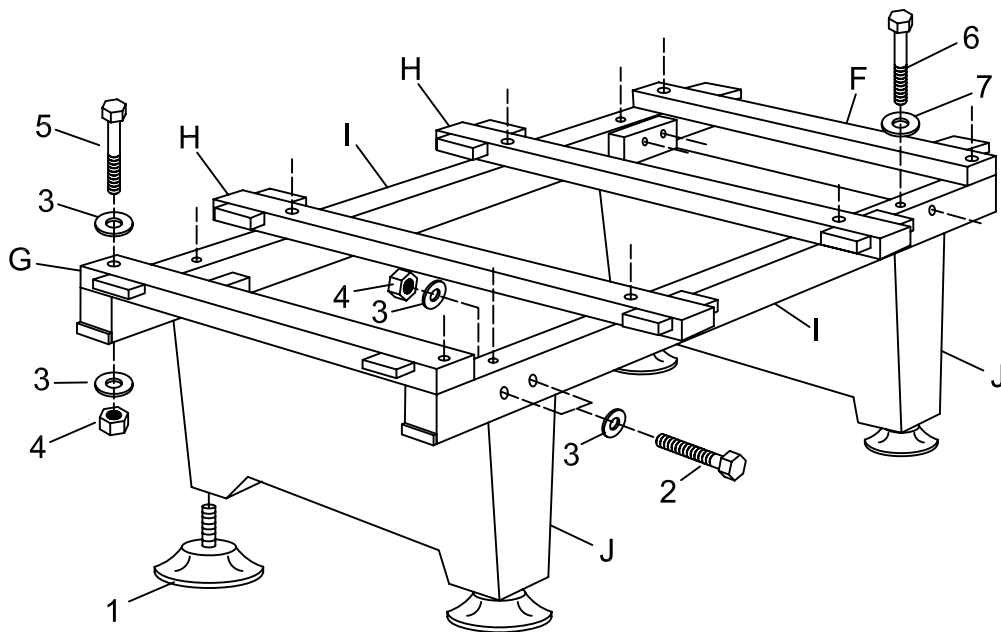

## Schritt 2:

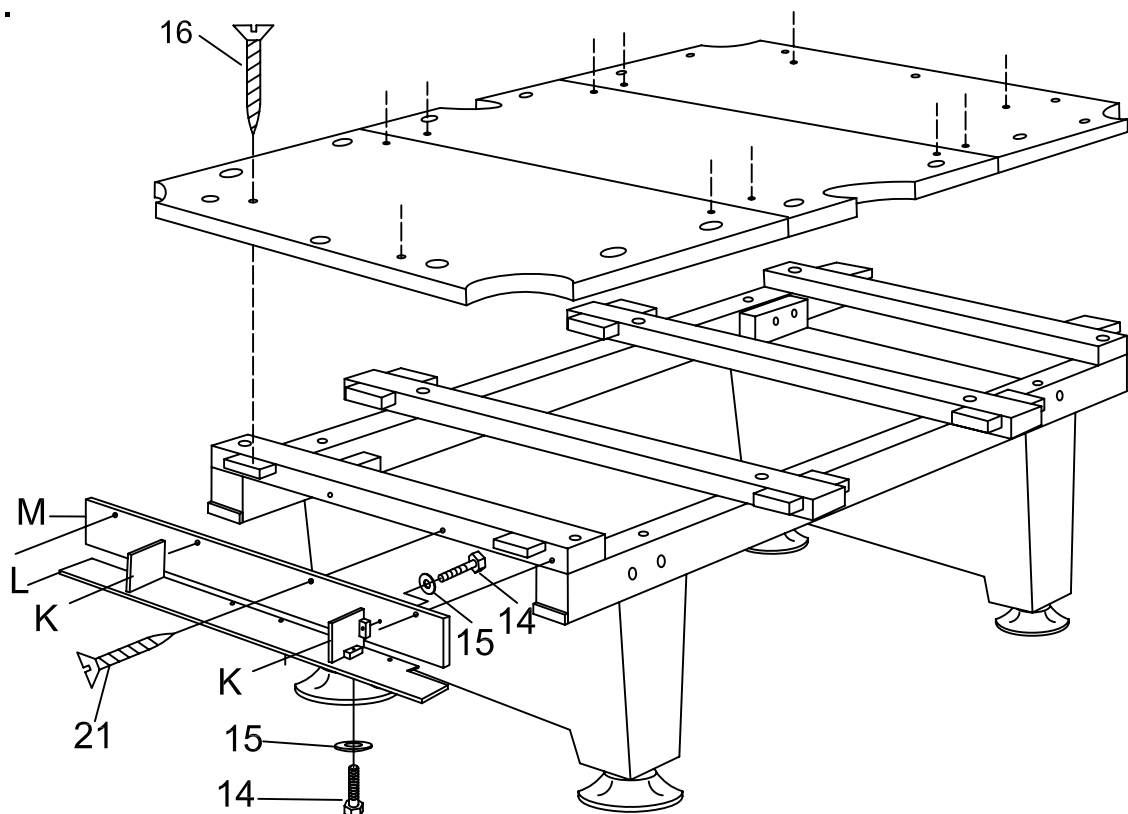

Schritt 3:

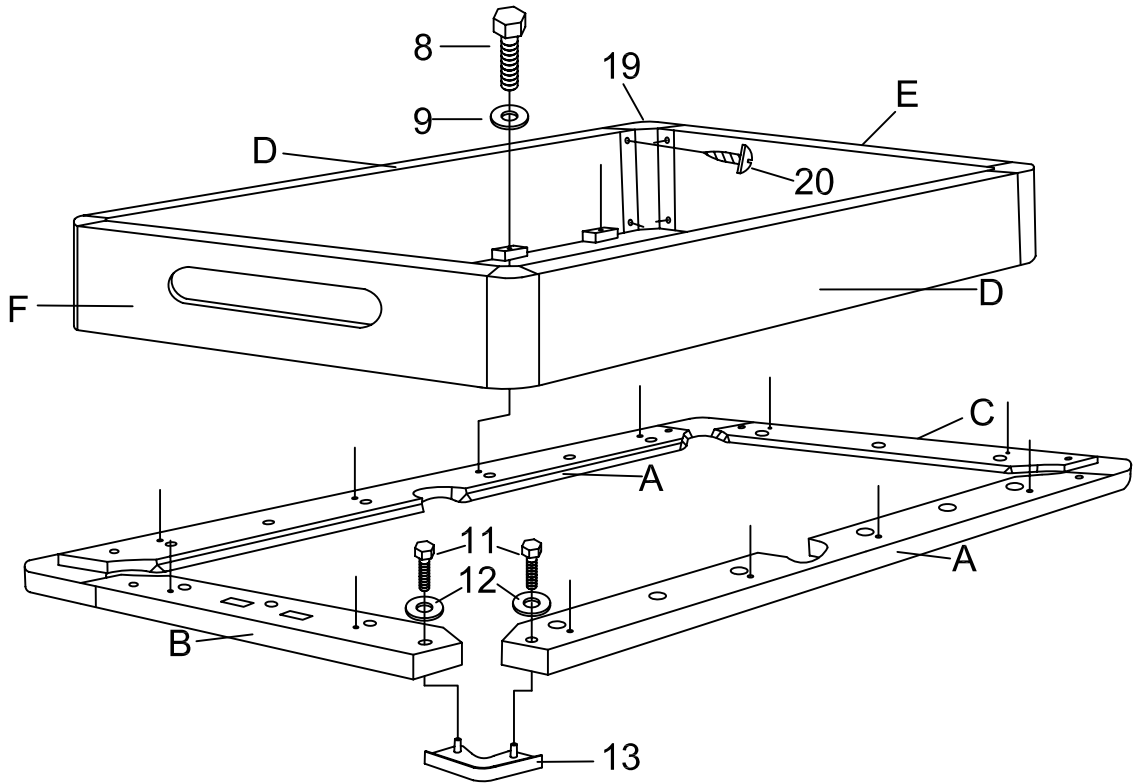

Schritt 4:

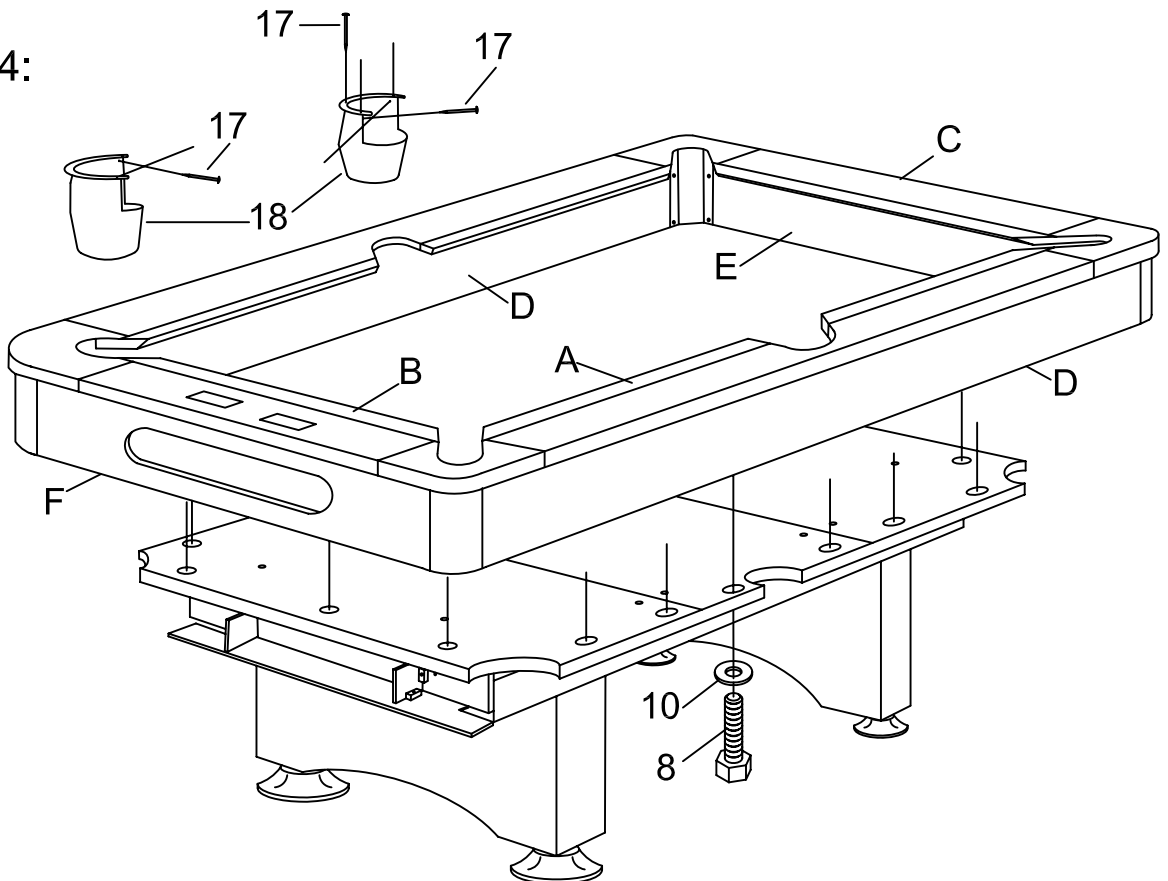



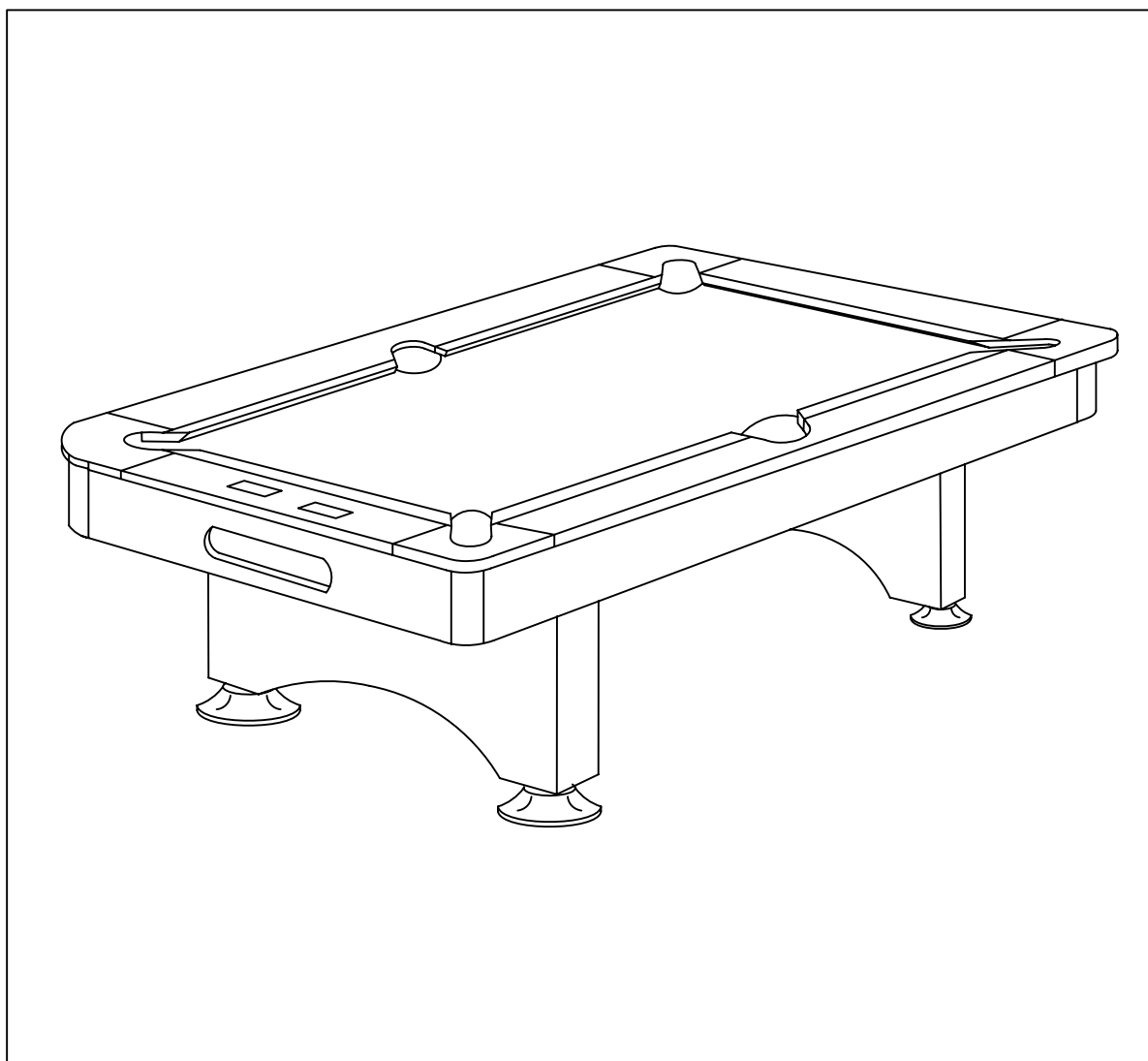





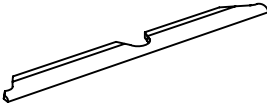
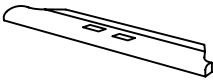

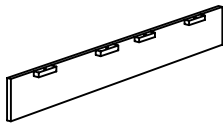
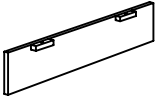
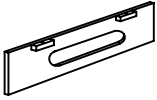
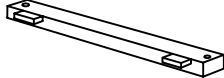
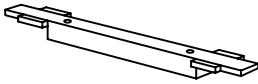
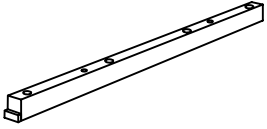
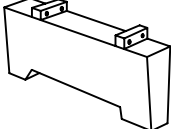
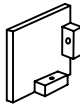
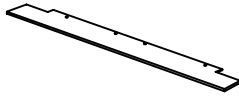
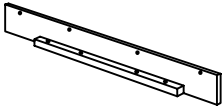



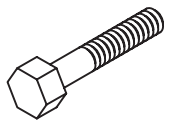

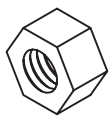
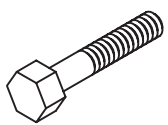
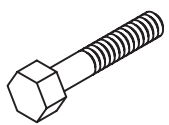

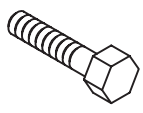
# POOL TABLE "OLYMPIC"

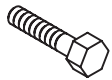

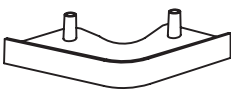
Item-No.: AUT-7147  
AUT-3153  
AUT-6097  
AUT-6093

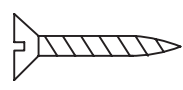
## Parts List

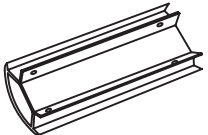
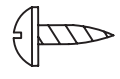
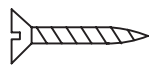
<p>A</p>  <p>Long top rail 2 pieces</p>	<p>B</p>  <p>End top rail (A) 1 piece</p>	<p>C</p>  <p>End top rail (B) 1 piece</p>	<p>D</p>  <p>Long apron 2 pieces</p>
<p>E</p>  <p>End apron (A) 1 piece</p>	<p>F</p>  <p>End apron (B) 1 piece</p>	<p>G</p>  <p>Cross Member 2 pieces</p>	<p>H</p>  <p>Mid Cross Member 2 pieces</p>
<p>I</p>  <p>Long Frame 2 pieces</p>	<p>J</p>  <p>Leg 2 pieces</p>	<p>K</p>  <p>Ball storage panel A 2 pieces</p>	<p>L</p>  <p>Ball storage panel B 1 piece</p>
<p>M</p>  <p>Ball storage panel C 1 piece</p>			

<p>#1</p>  <p>Leg level 4 pieces</p>	<p>#2</p>  <p>M10X4-1/2" Bolt 8 pieces</p>	<p>#3</p>  <p>3/8"X25mm Washer 32 pieces</p>	<p>#4</p>  <p>M10mm Nut 16 pieces</p>
<p>#5</p>  <p>M10X180mm Bolt 8 pieces</p>	<p>#6</p>  <p>M12X140mm Bolt 4 pieces</p>	<p>#7</p>  <p>13X28mm Washer 4 pieces</p>	<p>#8</p>  <p>5/16"X1-3/4" Bolt 30 pieces</p>
<p>#9</p>  <p>5/16"X23mm Washer 12 pieces</p>	<p>#10</p>  <p>5/16"X35mm Washer 18 pieces</p>	<p>#11</p>  <p>1/4"X1" Bolt 8 pieces</p>	<p>#12</p>  <p>1/4"X32mm Washer 8 pieces</p>
<p>#13</p>  <p>Top corner 4 pieces</p>	<p>#14</p>  <p>1/4"X1-3/4" Bolt 8 pieces</p>	<p>#15</p>  <p>1/4"X19mm Washer 8 pieces</p>	<p>#16</p>  <p>#12*2-1/2" Screw 12 pieces</p>
<p>#17</p>  <p>Nail 18 pieces</p>	<p>#18</p>  <p>Plastic pocket 6 pieces</p>	<p>#19</p>  <p>Apron Corner 4 pieces</p>	<p>#20</p>  <p>T4X12mm Screw 16 pieces</p>
<p>#21</p>  <p>F4*1-1/4" Screw 4 pieces</p>	<p>#22</p>  <p>Wrench 1 piece</p>		



### Step 1:

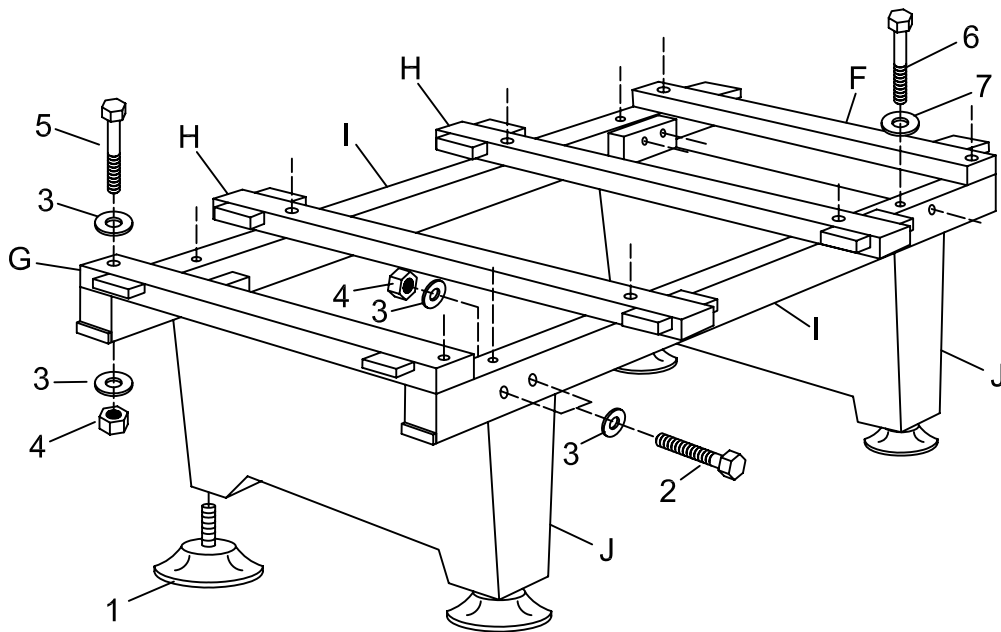

### Step 2:

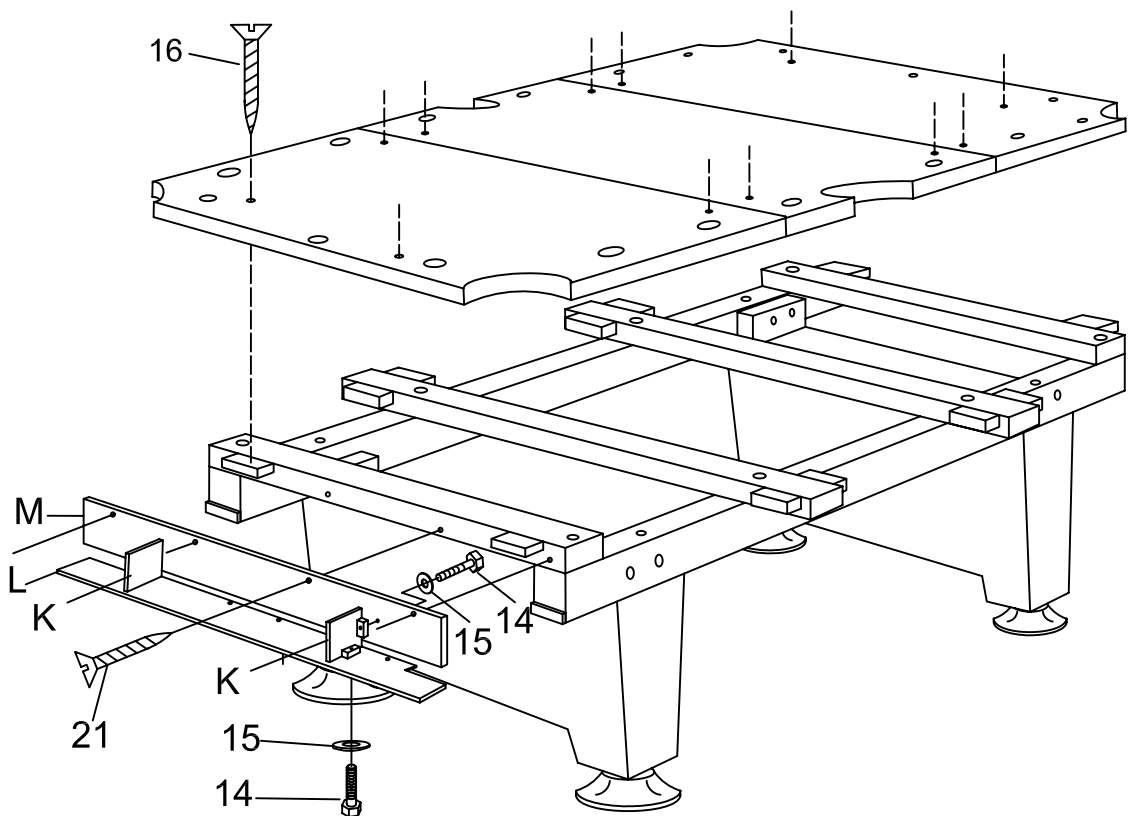

Step 3:

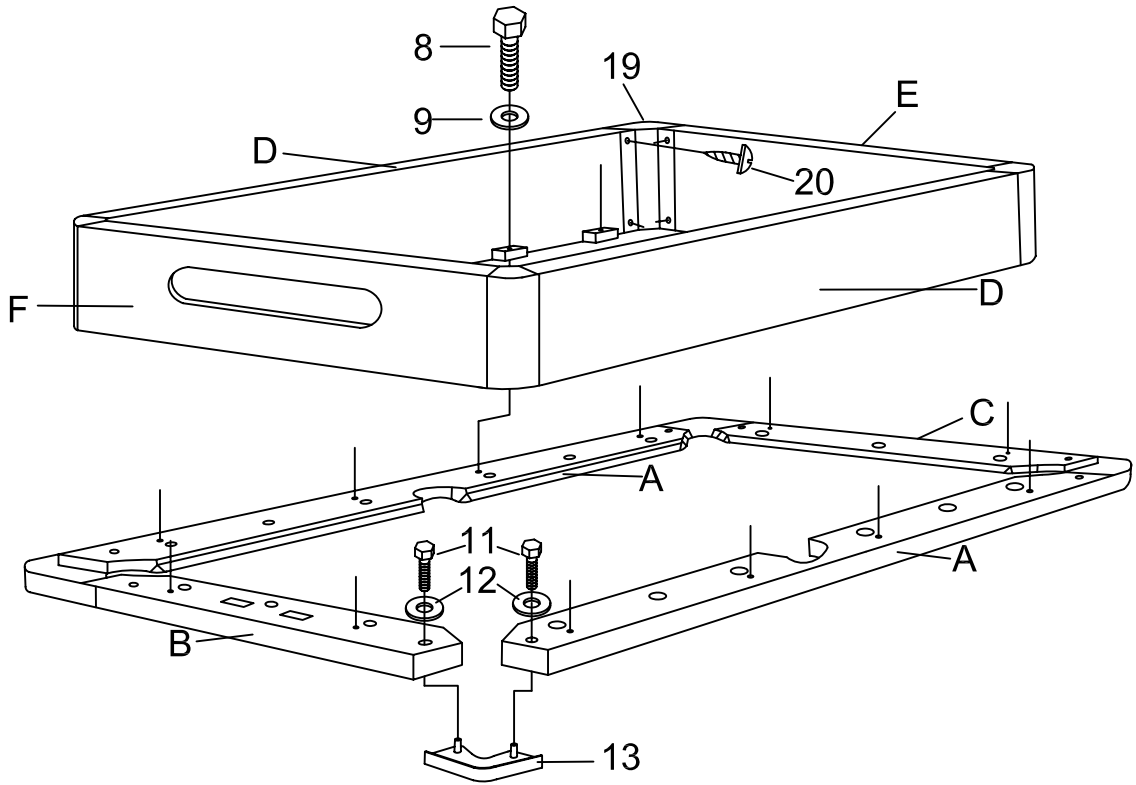

Step 4:

